







ASSEMBLY INSTRUCTIONS | BALBOA UPHOLSTERED BED

Step 1

Install type B angle irons on the headboard, side rails and footboard, then paste type X cotton pads on top of type C angle irons

PARTS CHECKLIST

A		Straight Irons (8 pcs)
B		Angle Irons (12 pcs)
M		Bolts 30*8mm (44 pcs)
N		Allen Key (1 pc)
X		Black Cotton Pad (12 pcs)
Y		Stand - 22cm Height (2 pcs)

NOTE: The type M bolts are not in the hardware kit. They are already pre-installed.

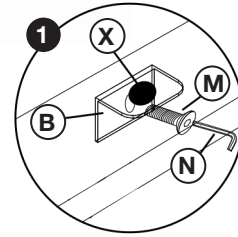
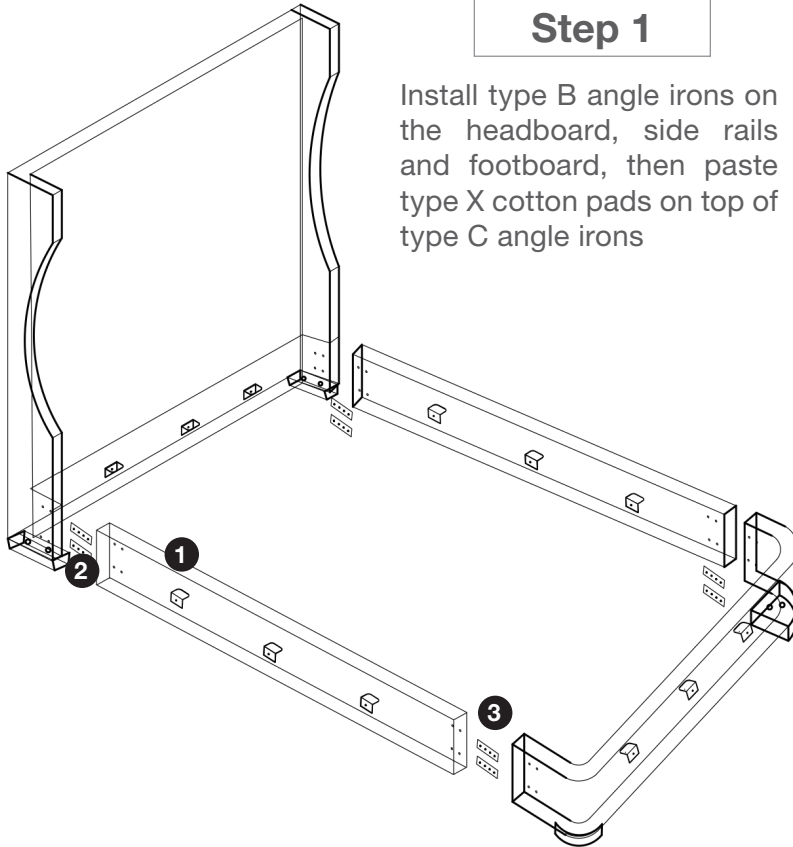

Step 2

Use type A straight irons to connect the headboard and side rails

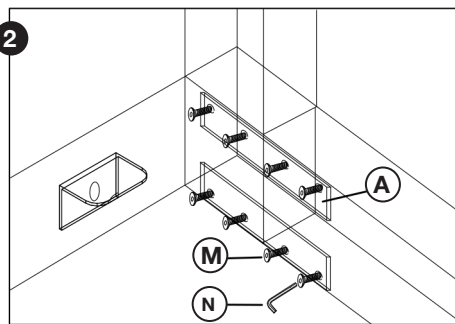

Step 3

Use type A angle irons to connect the side rails and footboard

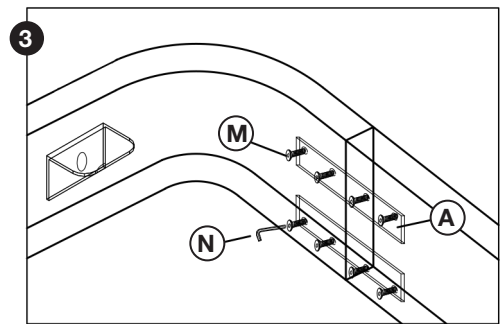

Step 4

Install the type Y stand to the middle of the slat. Type Y stand can be adjusted further as needed.

