

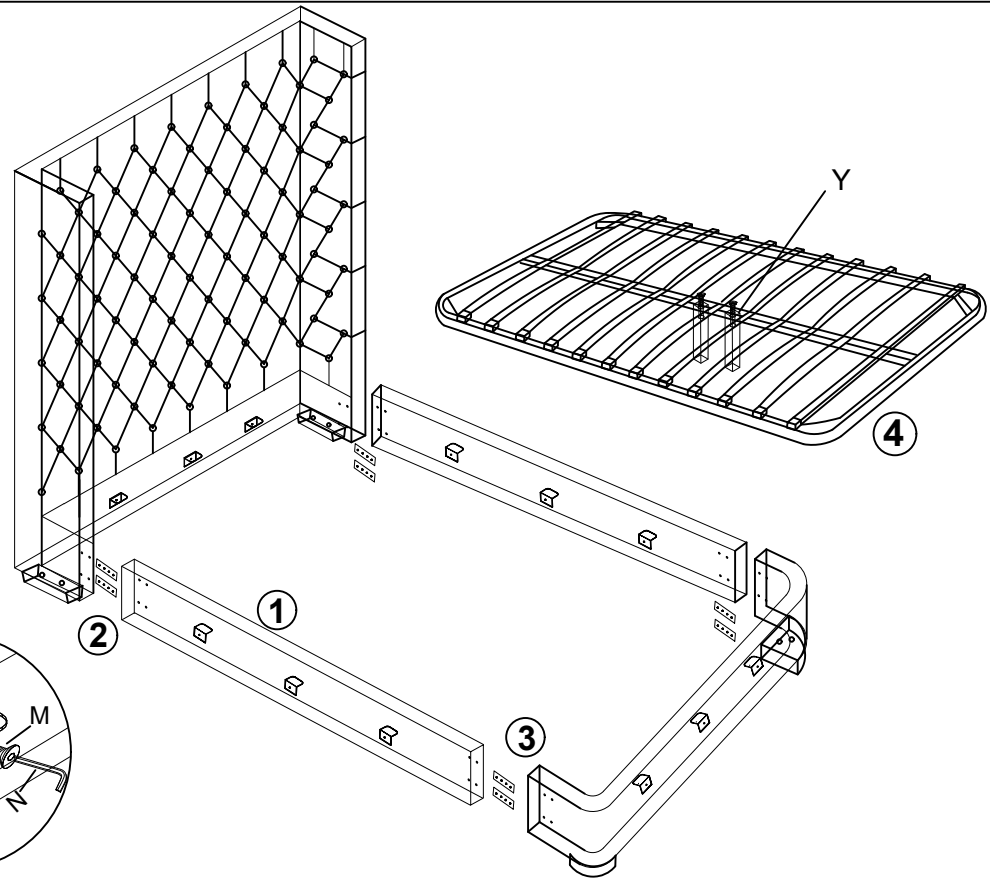





BARCLAY BED ASSEMBLY INSTRUCTIONS



Install slat brackets as shown

PARTS LIST		
A	8 Pcs	 X8
B	12 Pcs	 X12
M	44 Pcs	 30*8MM
N	1 Pcs	
X	12 Pcs	 black cotton pad diameter 28MM
Y	2 Pcs	 Height 22CM

ASSEMBLY STEPS	
①	Install 12pcs of Type B angle irons on the headboard, side rails and footboard, and then paste 12pcs of Type X on the top of C angle irons.
②	Use 4pcs of Type A straight irons to connect the headboard and side rails.
③	Use 4pcs of Type A straight irons to connect the side rails and footboard.
④	Put the folding slat in, install the 2pcs of Type Y legs to the middle of the folding slat.

Note: the 44pcs of Type M bolts are not in the hardware kit. They are already pre-installed.

