









ASSEMBLY INSTRUCTIONS | LIBRARY BOOKSHELF

PARTS CHECKLIST		
A		Bookshelf Leg (2pcs)
B		30"x5" Shelf (1pc)
C		30"x6.75" Shelf (1pc)
D		30"x8.75" Shelf (1pc)
E		30"x10.75" Shelf (1pc)
F		30"x13.75" Shelf (1pc)
G		Screw (10pcs)
H		Allen Key (1pc)



Step 1

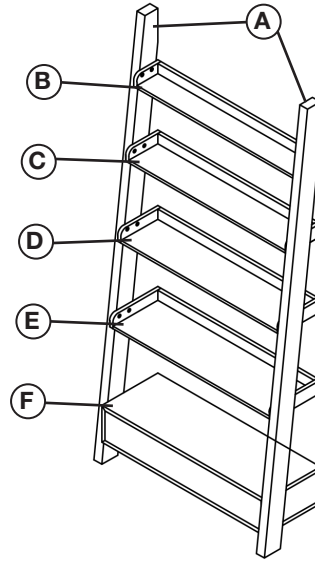
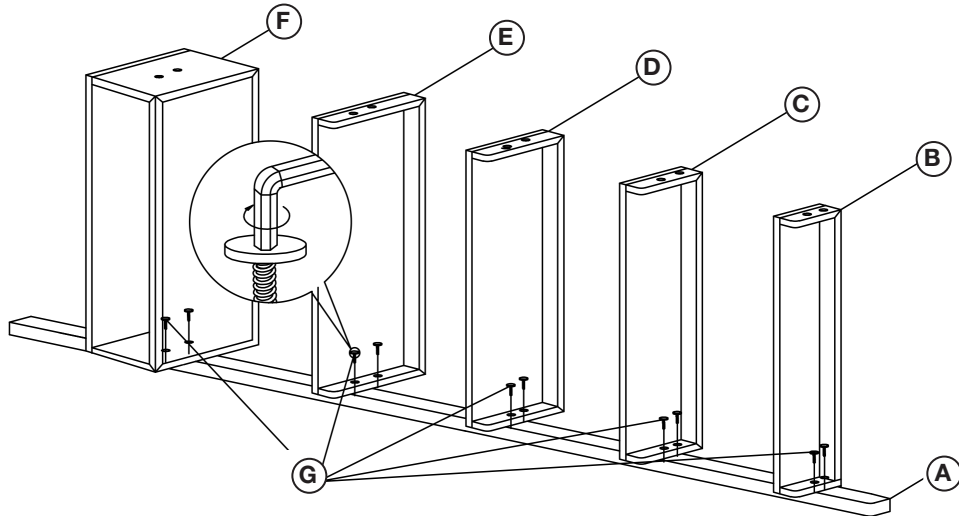

Step 2

