







ASSEMBLY INSTRUCTIONS | TAILOR SHELTER UPHOLSTERED BED

HARDWARE CHECKLIST		
A		Straight Irons (8pcs)
B		Angle Irons (12pcs)
M		Bolts 30*8mm (44pcs)
N		Allen Key (1pc)
X		Black Cotton Pad (12pcs)
Y		Stand - 22cm (2 or 3pcs)

Step 1

Install type B angle irons on the headboard, along the inside of the headboard, side rails and footboard. Then place type X cotton pads on top of type B angle irons

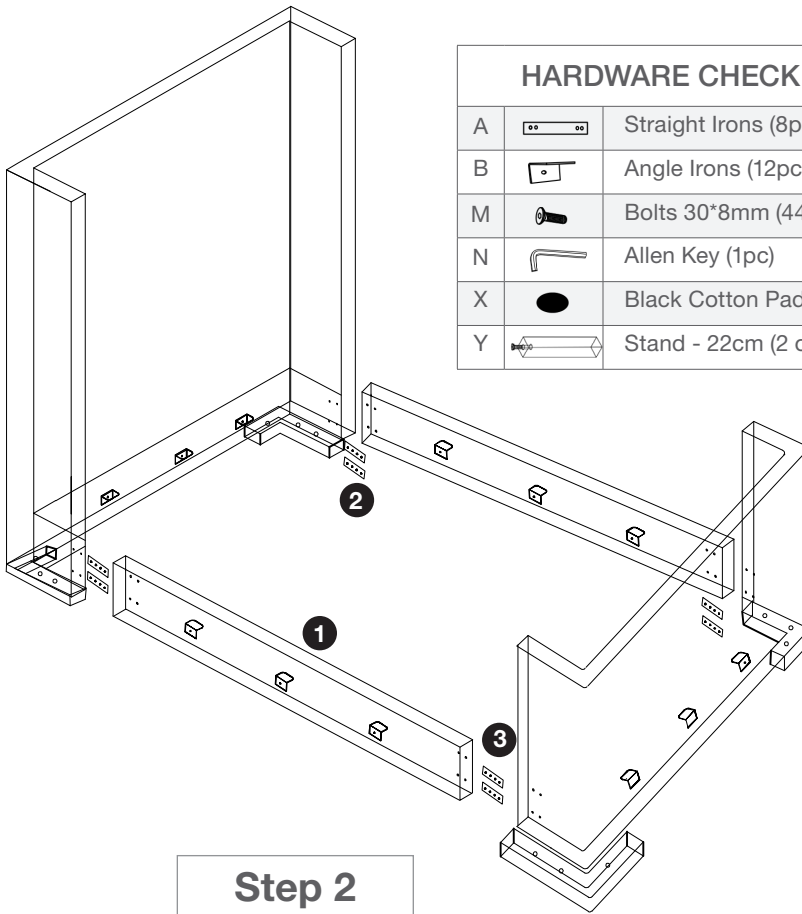
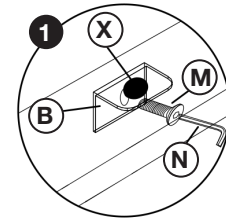

Step 2

Use type A straight irons to connect the headboard and side rails

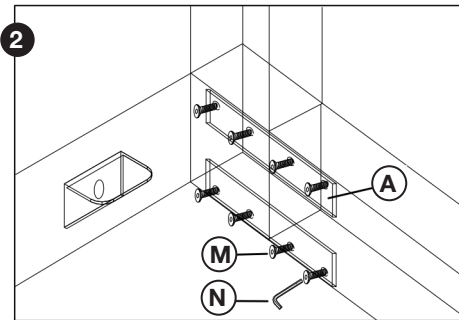

Step 3

Use type A straight irons to connect the side rails and footboard

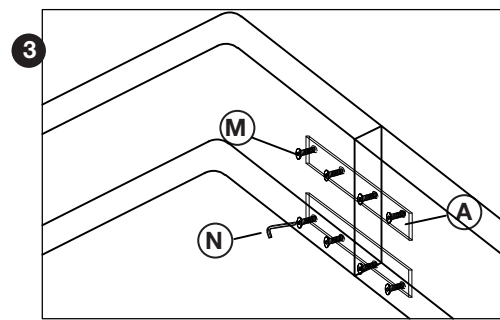

Step 4

For Queen Bed: Place slats on top of angle irons. Install the 2pcs type Y stands to the middle of the slat. Type Y stand height can be adjusted further as needed.

For Cal King & Std King Bed: Place slats on top of angle irons. Install the 3pcs type Y stands to the middle of the slat. Type Y stand height can be adjusted further as needed.

